

## Furniture Joining



---

### ASSEMBLY INSTRUCTIONS

# JOON LOLOI

## ASSEMBLY INSTRUCTIONS

Read these instructions carefully and keep for future reference. Refer to parts inventory for guidance, and ensure you have all pieces before starting. When assembling, place all parts on a soft, clean, and flat surface such as a carpet to prevent scratches.

HARDWARE INVENTORY			
ID	IMAGE	DESCRIPTION	QTY
<b>A</b>		ALLIGATOR CLIP A	1
<b>B</b>		ALLIGATOR CLIP B	1

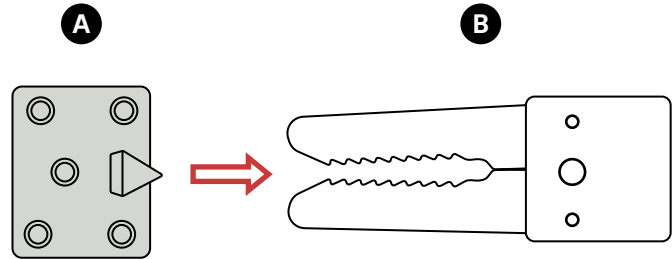

### STEP 1

On each piece of furniture, locate the mechanism parts **ALLIGATOR CLIP A** and **ALLIGATOR CLIP B**.

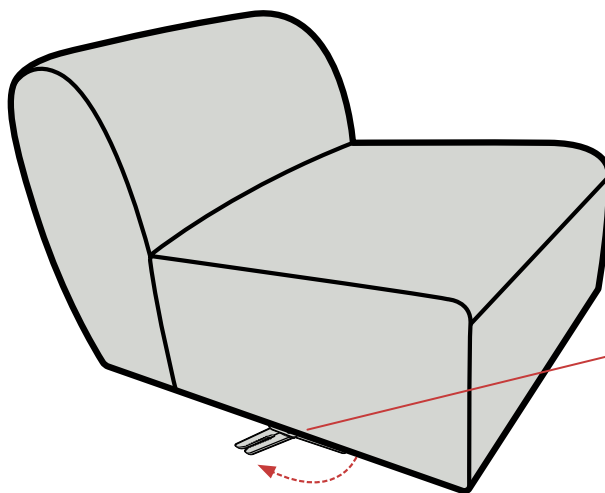

### STEP 2

Pull out **ALLIGATOR CLIP B** mechanism.

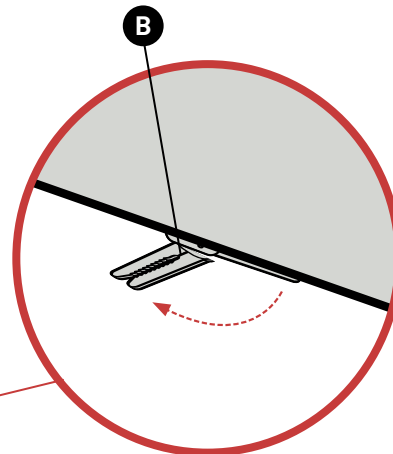

# JOON LOLOI

---

## STEP 3

Push both **ALLIGATOR CLIPS** together until **ALLIGATOR CLIP A** inserts into **ALLIGATOR CLIP B** and the mechanism clicks.

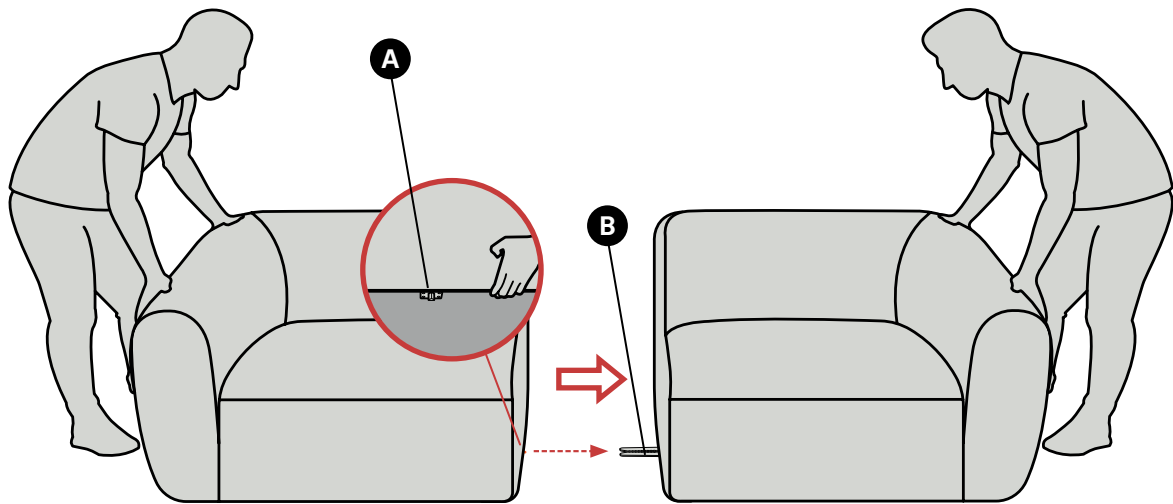

## BOTTOM VIEW OF SECTIONAL AND CLIP MECHANISM

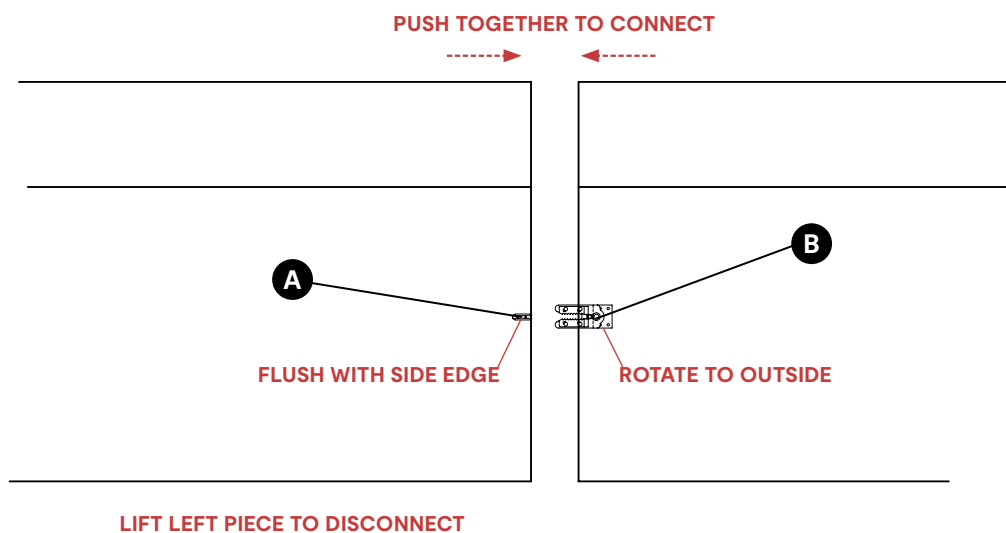

Make sure Alligator Clips are lined up evenly, approximately 3" apart.

Push both pieces of furniture together, a clicking sound should be heard as being pushed together.

TO DISCONNECT: Lift left piece up approximately 3" to release connector.